

ENGLISH

# 2 WIRE INTERCOM SYSTEM

---

USER MANUAL



---

Please read this manual carefully before using the product, and keep it well. DT-ENG-47M/TD7-V1

# 1. Parts and Functions

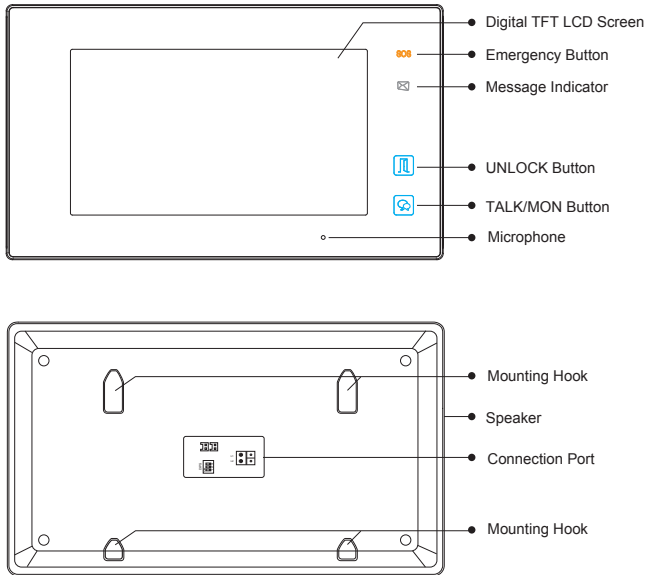

## Key functions

LCD screen	Display the visitors' image
Emergency button	Press it 3 seconds to send the SOS message
Message indicator	It will light when the monitor received the unread record
Unlock button	Press to release the door
Talk/Mon button	Press to communicate hands free with visitor Press to view the outdoor condition in standby mode
Microphone	Receive voice from the user
Mounting hook	Use to hang up the monitor
Connection port	Bus terminal
Speaker	Send out voice from the visitor

## DIP Settings

Bit	Bit State	Description
DIP1&2		Reserved. left to default.
DIP3		Set to OFF. When the monitor is in the middle of the line in daisy chain connection.
		Set to ON. When the monitor is at the end of the line or connected to a DBC4S.

## 2. Monitor Mounting

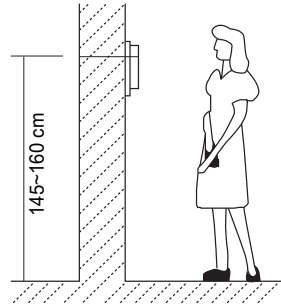
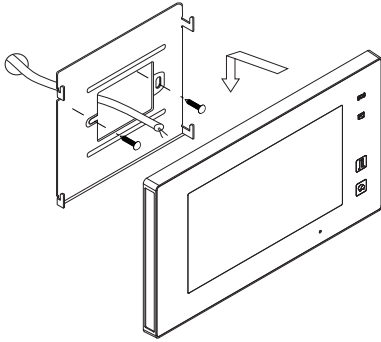



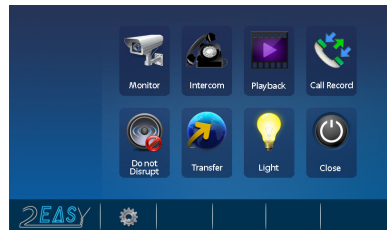

1. Use the screws to fix the Mounting Bracket on the mounting box.(fitting accessories includes a Bracket (Two pieces of 4X25 screws are needed for fastening the Mounting Bracket), Special 2 wire connectors to connect with Monitor)
2. Wire the system correctly(see the later connection chapter) then hang the Monitor on the Mounting Bracket firmly.

## 3. Main Menu







Touch the screen anywhere on monitor in standby mode, the main menu page will be shown as follows:





## 4. Basic Door Release Operation

1. Press **CALL** button on outdoor station, the Monitor rings, at the same time, the screen displays the visitors' image.
2. Press  **TALK/MON** Button on monitor or touch  icon on screen, you can communicate hands free with the visitor for 90 seconds.After finishing communication,press  **TALK/MON** button again or touch  icon to end the communication. If nobody answers the phone, the screen will be turned off automatically after 30 seconds.

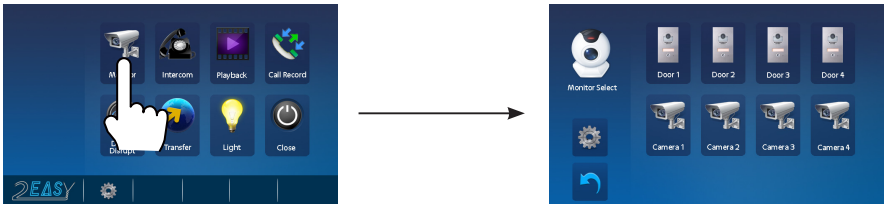

3. During talking state, Press  **UNLOCK** Button or touch  icon to open the door for the visitor.(if two locks are connected to door camera,touch  **unlock 2nd** icon to release the second lock )
4. When the monitor is in standby mode, press  **TALK/MON** Button, The screen can display the view of outside. Or touch  **Monitor** icon on main menu to get into the door camera switching mode, if multi door stations are installed, you can press the door 1/2/3/4 to monitor the door station or CCTV camera you want.press  icon to exit and enter main menu page.



Note: if the system connect 2 wire camera via camera controller, press the camera 1/2/3/4 to monitor the camera you want.press  icon to exit and enter main menu page.



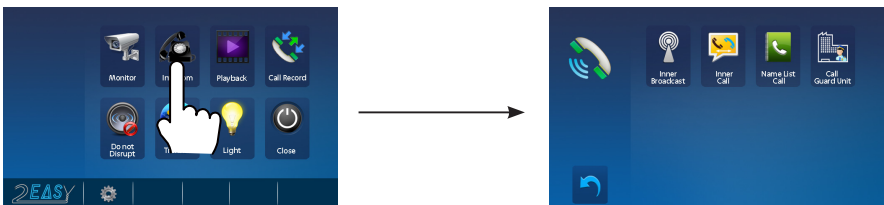

## 5. Intercom Function

Touch  **Intercom** icon on main menu to get into the intercom mode , you have 4 item to select:**Inner Broadcast**, **Inner Call**, **Name List Call** and **Call Guard Unit**.



1. **Inner Broadcast:** If multi slave monitors are installed in the same apartment, select Inner Broadcast, all the other monitors will mandatory receive broadcast content at the same time, whichever slave monitor doesn't need to answer the broadcast, and whichever slave monitor also doesn't need to open the screen.
2. **Inner Call:** If multi slave monitors are installed in the same apartment, select Inner

Call, all the other Monitors will ring at the same time, whichever Monitor answers the call, conversation is started.and the other monitors will stop ringing at the same time.

- Name List Call:** User in one apartment can call other apartments in the system. Touch  Name List Call icon (the namelist will be created automatically by the system) on intercom mode menu page, Select a name on the screen then touch  icon to call.Press  /  icon to enter last/next name list page. (Touch Dial Number icon again to redial)

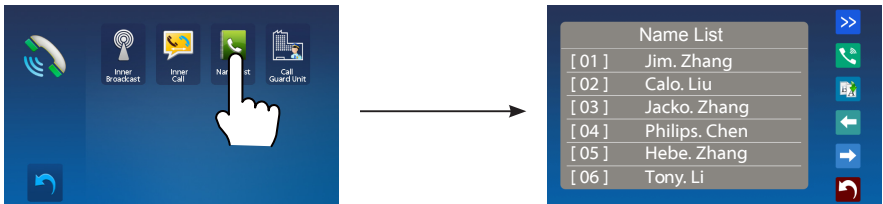



- Call Guard Unit:** A Monitor can be assigned as Guard Unit Monitor; when the Guard Unit Monitor answers the call, conversation with the guard person is started..

## 6. Video/Picture Memory

### Video/Picture Recording

Both Auto-Recording and Manual-Recording are available.And Auto-Recording is default. If receive a call , after 3s, the monitor will record one video/picture for each calling automatically. Or you can touch  icon to record the visitor's video/image manually when the monitor is in monitoring or calling.

### Video/Picture Playback

Touch  **Playback** icon on main menu, the recorded videos/pictures will be played on screen, please note that touch  icon to Start/Pause the videos recorded.

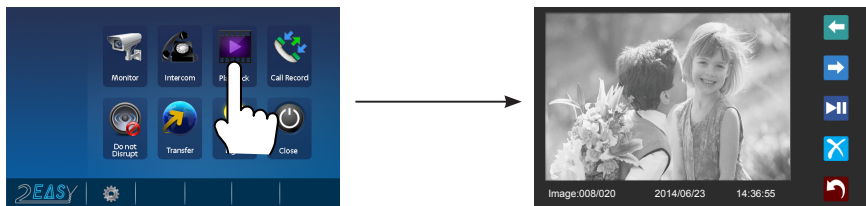



Note: When the system without SD card: 1.118 pictures in inner memory  
 2.Manage each picture.

When the system with SD card:1.Up to 32G Micro SD card  
 2.Video & Audio record  
 3.Manage each video clips  
 4.Can be copied

## 7. Call Record Function

Call Record:All the calls concerning the montior, including Door-station-to-monitor call, monitor-to-monitor call, will be recored and can be reviewed afterwards.

Touch  Call Record icon on main menu to get into the call record mode.When there are unread call records, arrow color red. Press the unread call record, and then touch  icon to play it.

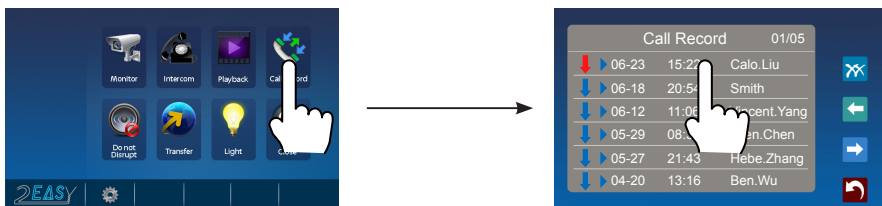

Note: 1.Automatic limited number of records.

2.Do not need to delete any a record.



## 8. Do Not Disturb Function

Touch  **Do Not Disturb** icon on main menu to get into the don't disturb mode , you have 4 item to select:**Normal, In 1 Hour, In 8 Hours** and **Always**. You can select the appropriate item according to your needs.

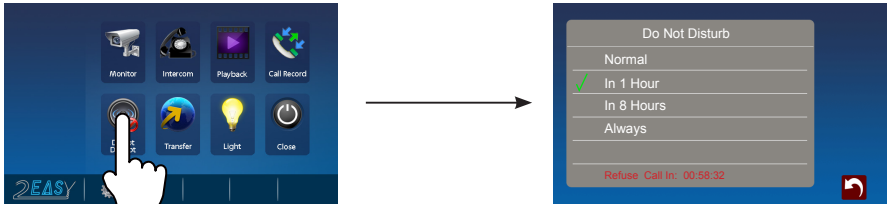

Note: When you select "In 1 Hour" or "In 8 Hours", bottom of the screen will display the remaining time.

## 9. Transfer Function

Touch  **Transfer** icon on main menu to get into the transfer mode. Touch the empty place ,and then input the telephone number by pressing the digital keypad.And it has 3 types of divert modes:

1:Don't Transfer----calls from outdoor station will not be diverted.

2:If No Answer----outdoor station calls indoor monitor firstly,if nobody answer the call within 30 seconds,the call will be diverted to the telephone number you set. At this mode,the monitor will shut off immediately when TPC/GSM/TPS divert sucessfully,while it won't affect the communication between TPC/GSM/TPS and outdoor station.Otherwise, the monitor can do the operation of monitoring,talking,and unlocking.

3:Simultaneously----calls from outdoor station will be diverted to your telephone immediately.At this mode,the monitor won't shut off when TPC/GSM/TPS divert sucessfully,but if the monitor answers the call at this time,TPC/GSM/TPS will quit absolutely.

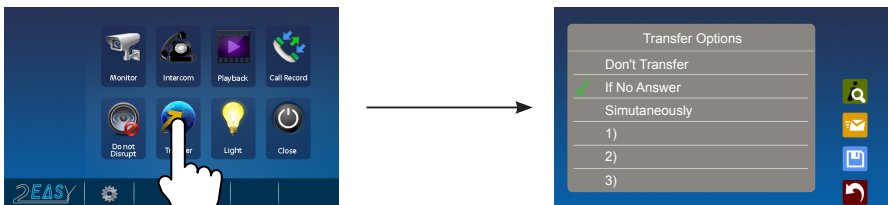

Note:1. Touch  icon to detect the transfer device info.

2. Touch  icon to send message.

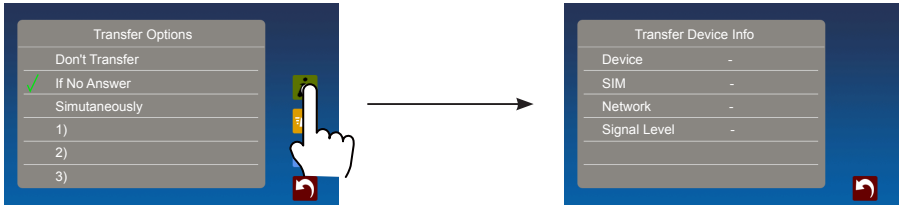



## 10. Staircase Light

Note: the staircase light function will be activated only when the system connect light via SC6V module, otherwise, this function is unvalid in normal. For more information, please refer to SC6V user instruction in detail.

On main menu page or in monitoring,touch **Light** icon to open the staircase light, the staircase light will be turned off automatically.

## 11. Basic Setup Instructions

### Sounds Settings

Touch  icon on main menu page(or on door camera switching mode page), then select "Sounds" item to enter the sounds settings page.You can set a variety of ring tones on this page.(touch  icon to exit the setting and return main menu page.

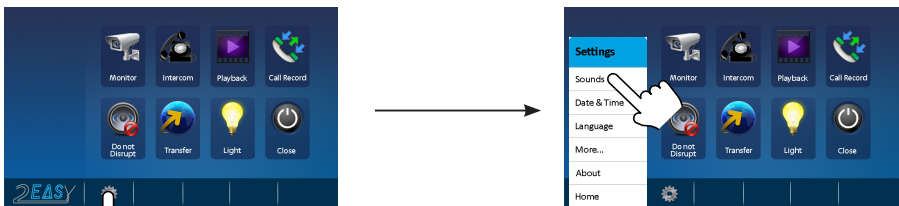



Note: Door Ring have 2 mode:United and Seperate.If select "United",it means Door1/2/3/4 as a whole to adjust the ring tones.





## Date & Time Settings

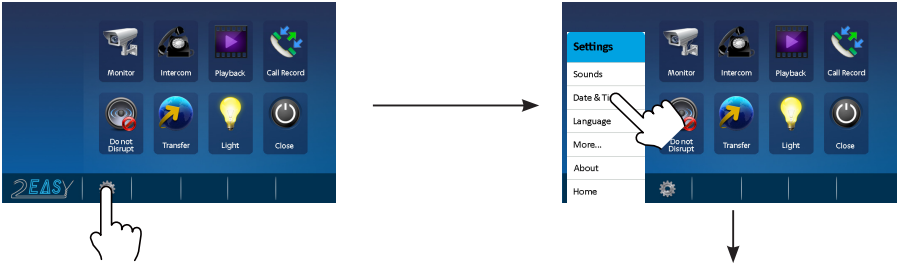

Touch  icon on main menu page(or on door camera switching mode page), then select **"Date & Time"** item to enter the date & time settings page.You can set the date & time on this page.(touch  icon to exit the setting and return main menu page.

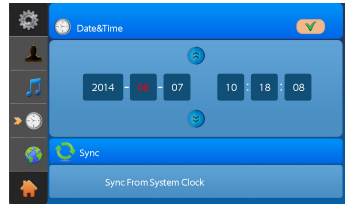

Note: You can set your own time, you can also synchronize the system time.



## Rename & Monitor Time Settings

Touch  icon on main menu page(or on door camera switching mode page), then select **"More..."** item to enter the Rename & monitor time settings page.You can set door station rename, camera rename, monitor time on this page.(touch  icon to exit the setting and return main menu page.



Note: If you want to rename, please touch the place of name, then it will turn keypad page ,you can input your new name in this page.

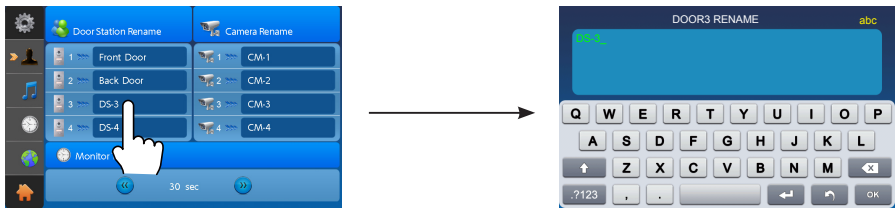

## Screen and Volume Adjustment

During monitoring or talking state, touch  icon,the Adjust page will be displayed.

1. The Scene mode selection: Total 4 screen modes can be selected in sequence: **Normal**, **Brightly**, **Soft** and **User**. Whenever you modify **Brightness** or **colour**, **Scene** item will be set to **User** mode automatically.
2. Note that all the modifications will be performed immediately after the operation. Touch the window of image to exit the adjust page.

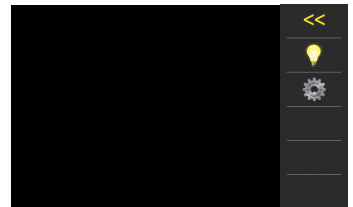



## 12. SOS SMS Function

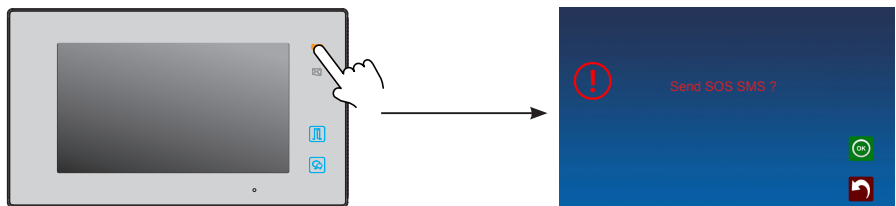



When the monitor is in standby mode, press Emergency button for 3 seconds to enter the SOS SMS page, touch  icon to send the SOS SMS.



# 13. Restore to Default

The restore to default function allows the user to recover the settings to factory setting. Note that the restore to default operation will not change the setting and datas.

Enter main menu page, and touch  icon, then select "About" item (or touch logo position) to enter the about settings page, touch  icon, the default settings will be loaded.

touch  icon to enter the Memo Information page, touch  and  icon to copy the pictures to SD card. Touch  and  icon to format SD card and restart.

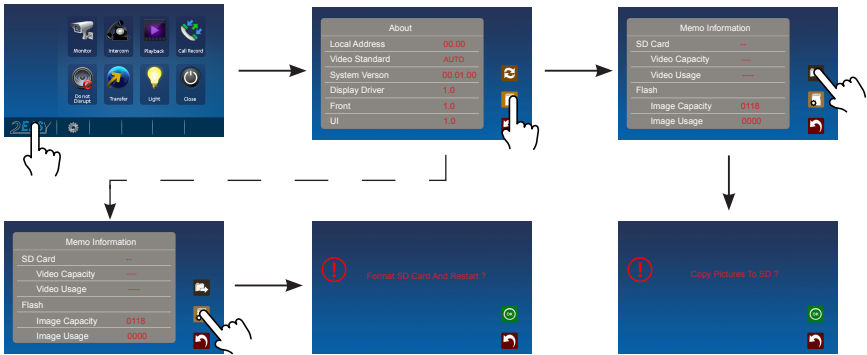

# 14. Monitor Parameter Setting

## How to enter the installation setting page



1.Touch  icon on main menu page.

2.Touch  UNLOCK button and hold for 2s.

3.A digital keypad will be shown.

## How to set the monitor as a Guard Monitor

A Monitor can be assigned as Guard Unit Monitor; when the Guard Unit Monitor answers the call, conversation with the guard person is started..

The code number of 8004 is used to set the monitor as a guard unit monitor and 8005 is used to cancel this function.

## How to set the slave monitor address

Maximum 4 monitors can be connected in one apartment,one master monitor together with 3 slave monitors, so you should set the address correctly.(note:must have one monitor to be set as master monitor)

The code of 8000 is used to set the master monitor.

The code of 8001 is used to set the first slave monitor .

The code of 8002 is used to set the second slave monitor .

The code of 8003 is used to set the third slave monitor .

## How to set date and time format

The system offers two methods of date and time.

The code number of 8008 is used to set the date format as month/date/year

The code number of 8009 is used to set the date format as date/month/year

The code number of 8012 is used to set the time format as 12 hour system

The code number of 8013 is used to set the time format as 24 hour system

## How to set the monitor panel on

In default mode,when receive a calling,the master and slave monitors will ring at the same time,and just the master monitor can display the image while the slave monitors can not.But the settings can be changed,you can set the master monitor and all the slave monitors to panel on at the same time when receiving a call, just input the code number of 8006 on each slave monitor.

Press call button  
on door station



When receiving calling,all monitors can display the image at the same time



Master monitor



#1st slave monitor



#2nd slave monitor



#3rd slave monitor

## How to set the unlock parameter

### Unlock mode:

There are two unlock modes: 1.power-on- to-unlock type:unlock mode=0(by default)  
2.power-off-to-unlock:unlock mode=1.

The code number of 8010 is used to set the unlock mode to 0

The code number of 8011 is used to set the unlock mode to 1

### Unlock time:

The unlock time can be changed by yourself at any time.it can be set from 1 to 9 seconds.

The code number from 8021 to 8029 are used to set the unlock time to 1~ 9 seconds.

## How to set the user code for the monitor

Each monitor should be assigned an address in the system, total 32 addresses can be configured, the code number of 8200 to 8231 is used to controlled the address of 00 to 31. Please refer to the following table.

Input No.	User Code	Input No.	User Code	Input No.	User Code
8200	Code=0	8211	Code=11	8222	Code=22
8201	Code=1	8212	Code=12	8223	Code=23
8202	Code=2	8213	Code=13	8224	Code=24
8203	Code=3	8214	Code=14	8225	Code=25
8204	Code=4	8215	Code=15	8226	Code=26
8205	Code=5	8216	Code=16	8227	Code=27
8206	Code=6	8217	Code=17	8228	Code=28
8207	Code=7	8218	Code=18	8229	Code=29
8208	Code=8	8219	Code=19	8230	Code=30
8209	Code=9	8220	Code=20	8231	Code=31
8210	Code=10	8221	Code=21		

## 10. Specification

- Power supply for indoor monitor: DC 20~28V
- Power consumption: Standby 12.4mA; Working 270mA
- Monitor screen: 7 Inch digital color LCD
- Display Resolutions: 800\*3(R, G, B) x 480 pixels
- Video signal: 1Vp-p, 75Ω, CCIR standard
- Wiring: 2 wires, non-polarity
- Dimension: 131(H) × 225(W) × 18(D)mm

## 11. Precautions

- 1) All components should be protected from violence vibration. And not allow to be impacted, knocked and dropped.
- 2) Please do the cleanness with soft cotton cloth, please do not use the organic impregnant or chemical clean agent. If necessary, please use a little pure water or dilute soap water to clean the dust.
- 3) Image distortion may occur if the video monitor is mounted too close to magnetic field e. g. Microwaves, TV, computer etc.
- 4) Please keep away the monitor from wet, high temperature, dust, caustic and oxidation gas in order to avoid any unpredictable damage.
- 5) Must use the right adaptor which is supplied by the manufacturer or approved by the manufacturer.
- 6) Pay attention to the high voltage inside the products, please refer service only to a trained and qualified professional.



DT-ENG-47M/TD7-V1

---

The design and specifications can be changed without notice to the user. Right to interpret and copyright of this manual are preserved.